

DISTANCES ET NOMBRE POSTES MAXIMUM INTERPHONIE

	Nbre max de postes	A	B	A + B	C	CUMUL DE TOUS LES SEGMENTS
Câble URMET REF : 1083/90	127	50m	200m	200m	200m	800m
SYT1 0,5mm OU 0,8mm	64	50m	150m	150m	100m	600m
CAT5 UTP une paire torsadée	64	50m	125m	125m	100m	800m
HVV05-F 1,5mm ²	127	50m	125m	125m	50m	300m
Câble 1mm ²	32	50m	50m	75m	50m	150m

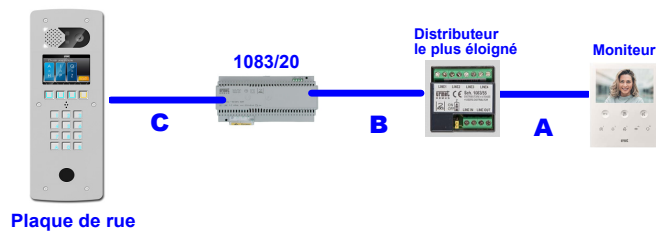

DISTANCES CONTROLE ACCES CV1083

	Alim Centrale	Alim Ventouses	Bus Plat Cent (B2F IN- D+ D-)	Bouton sortie (BP+ BP-)
Câble URMET REF : 1083/90	50m	50m	/	/
Câble 1mm ²	50m	50m	/	/
HVV05-F 1,5mm ²	100m	100m	/	/
SYT1 0,8mm	25m	25m	100m	100m



Le carter métallique doit être relié à la terre en utilisant l'écrou de fixation prévu à cet effet.

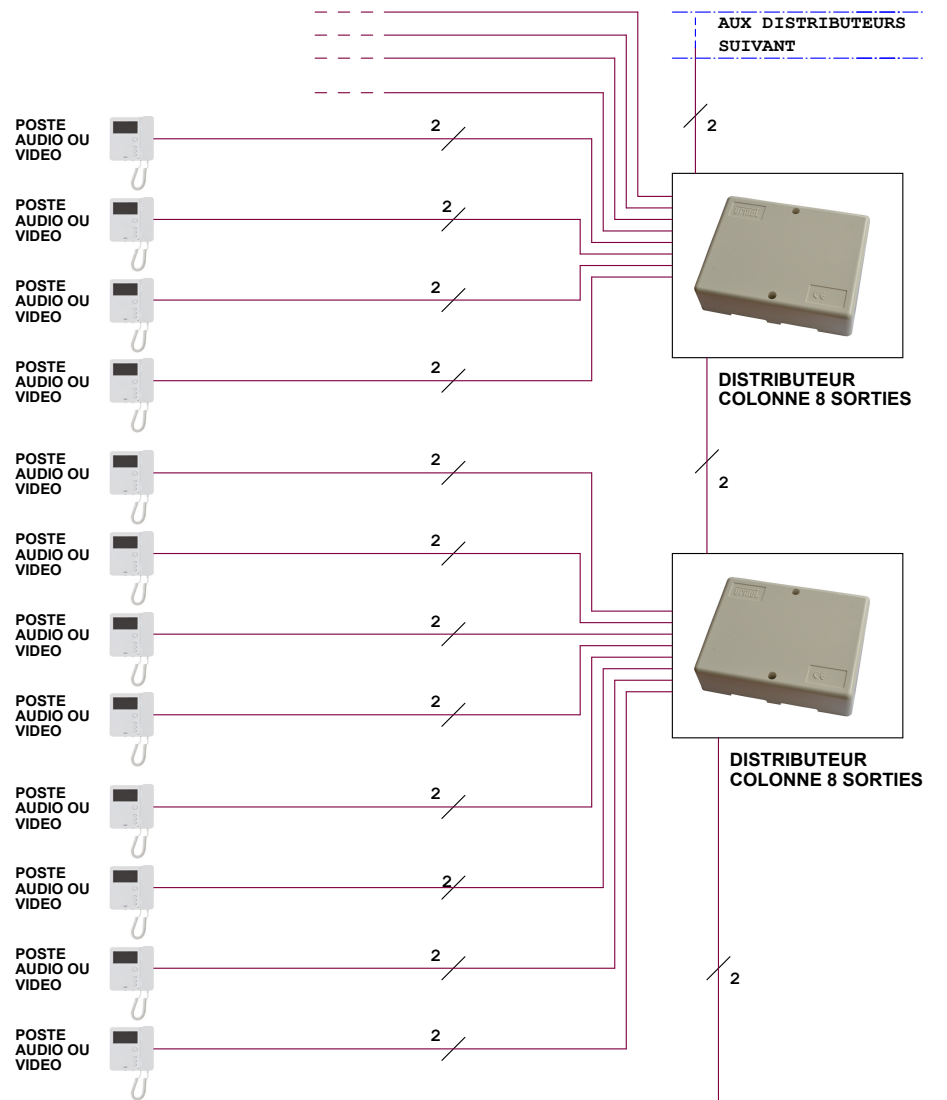

"LOCAL TECHNIQUE"

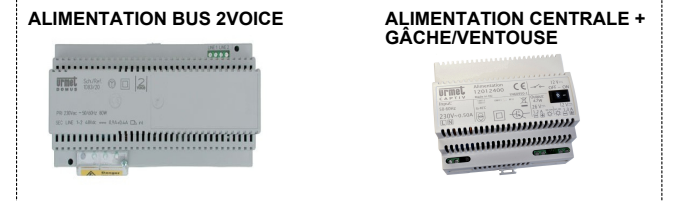

PLAQUE DE RUE VIDEO 2VOICE AVEC LECTEUR T25VK2

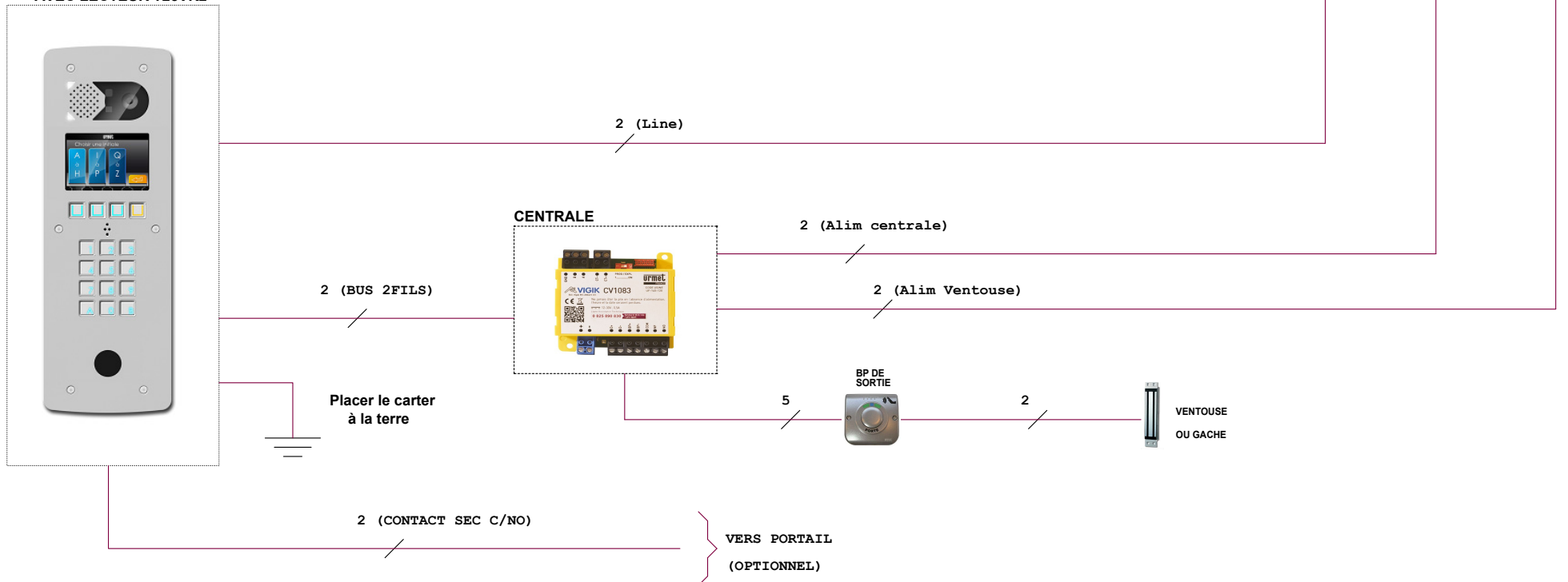

MATERIEL UTILISABLE SUR CE TYPE D'INSTALLATION :

- PLAQUE DE RUE VIDEO 2VOICE: REF : D83/I OU REF : D83/IG OU REF : D83/IGLP OU REF : D83/IGLPPT OU REF : D83/IGPT OU REF : D83/ILP OU REF : D83/ILPPT OU REF : D83/IPT OU REF : D83/ZG OU REF : D83/ZGLP - TÊTE DE LECTURE: REF : T25VK2	- CENTRALE : REF : CV1083 - CARTE RELAIS : (OPTIONNEL) REF : C83/2R	- ALIMENTATION BUS 2VOICE: REF : 1083/20 - CÂBLE BUS 2VOICE: REF : 1083/90 (100m) OU REF : 1083/95 (500m)	- DISTRIBUTEUR COLONNE REF : 1083/55 (4 sorties) OU REF : 1083/57 (8 sorties)	- POSTES REF : 1183/4 REF : 1183/5 REF : 1183/7 OU OU - MONITEURS REF : 1750/1 REF : 1760/6 REF : 1719/1 OU OU	- BOUTON DE SORTIE REF : BP2GML - ALIMENTATION CENTRALE + GÂCHE/VENTOUSE REF : 12012400
--	--	---	---	---	--

Le schéma n'est valable qu'avec les références produits indiquées. Pour toute modification, veuillez prendre contact avec le service technique.

AUX DISTRIBUTEURS
SUIVANT

PREMIER
DISTRIBUTEUR
REF : 1083/57

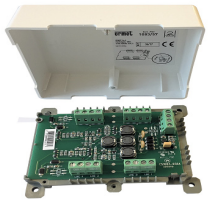

PLACER LE CAVALIER SUR ON
DU DERNIER DISTRIBUTEUR

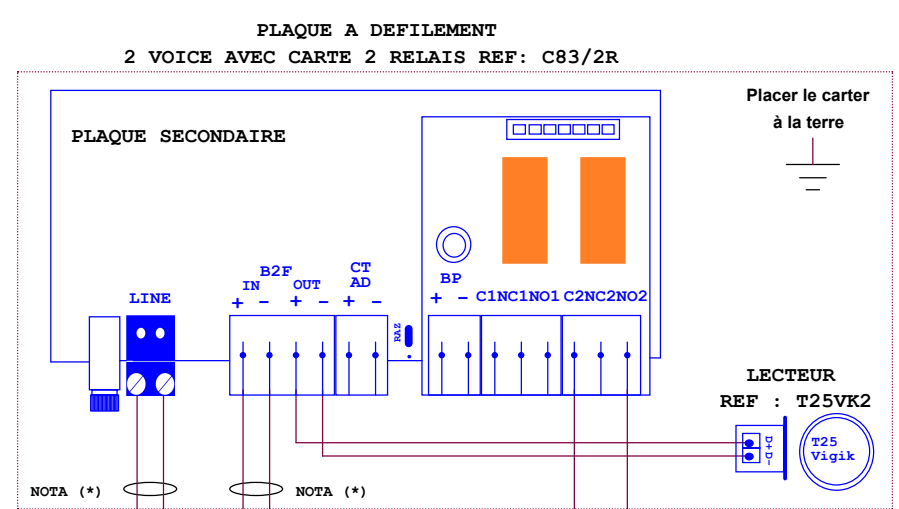
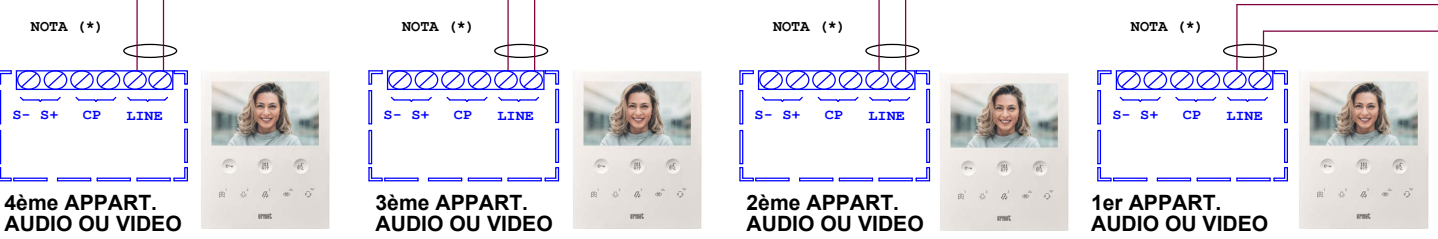
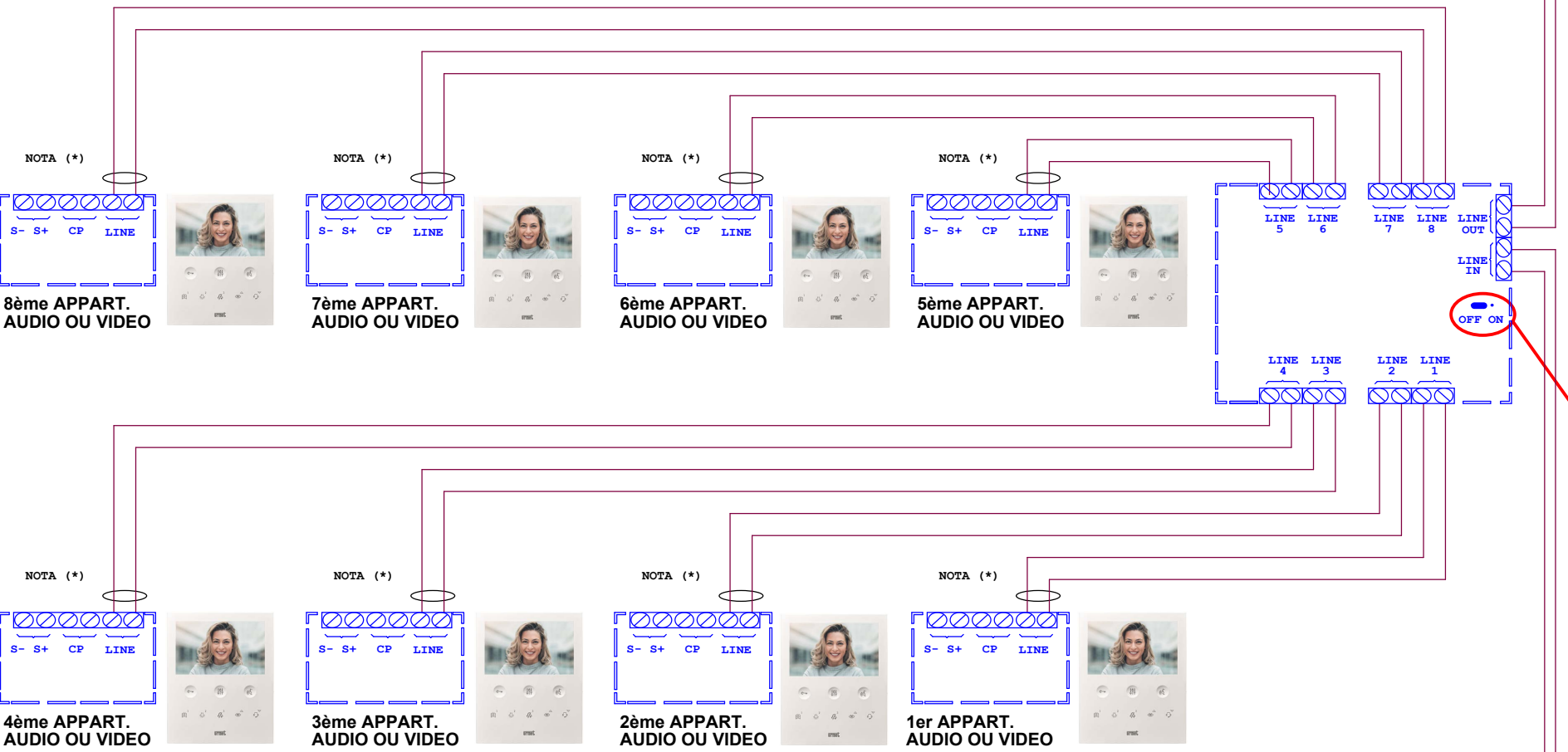

REF : D83/IG



NOTA (*) :
Utiliser un câble indépendant
pour cette liaison.

VERS PORTAIL
(OPTIONNEL)

ALIM. 2VOICE
REF : 1083/20

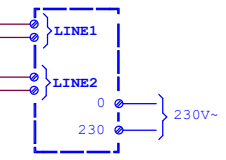

CENTRALE CONTROLE D'ACCES
REF : CV1083

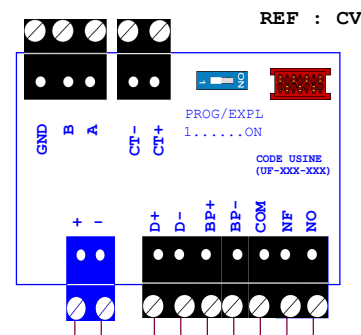

BOUTON DE SORTIE
REF : BPZGML



VENTOUSE
ou
GACHE 1T

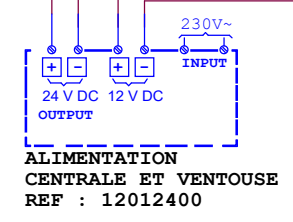

ALIMENTATION
CENTRALE ET VENTOUSE
REF : 12012400

Pour la codification des postes,
voir la notice de l'alimentation 1083/20,
ou télécharger l'application URMET 2 SET.

"Schéma de Câblage"			
1 PLAQUE A DEFILEMENT 2VOICE AVEC CV1083 AVEC ALIMENTATION 12012400			
CREE LE: 10/2019	CREE PAR: JCH	MODIFIE LE: 06/2023	N° MODIF.1
			SCH: TV6839 2/2