



MATERIEL UTILISABLE SUR CE TYPE D'INSTALLATION :

- PLAQUE DE RUE VIDEO 2VOICE:
REF : D83/I
OU REF : D83/IG
OU REF : D83/IGLP
OU REF : D83/IGLPT
OU REF : D83/IGPT
OU REF : D83/ILP
OU REF : D83/ILPT
OU REF : D83/IPT
OU REF : D83/ZG
OU REF : D83/ZGLP



- CENTRALE :
REF : CV1083



- ALIMENTATION CENTRALE
REF : 8500/2



- ALIMENTATION BUS 2VOICE:
REF : 1083/20



- DISTRIBUTEUR COLONNE
REF : 1083/55 (4 sorties)
OU
REF : 1083/57 (8 sorties)



- POSTES
REF : 1183/4
OU
REF : 1183/5
OU
REF : 1183/7



- BOUTON DE SORTIE
REF : BA/OF/80LH ou BPZGML



- ALIMENTATION GÂCHE/VENTOUSE
REF : AL12/2DIN



- CÂBLE BUS 2VOICE:
REF : 1083/90 (100m)
OU REF : 1083/95 (500m)



- INTERFACE COLONNE
REF : 1083/53



- MONITEURS
REF : 1750/1
OU
REF : 1760/6
OU
REF : 1719/1



- TÊTE DE LECTURE:
REF : T25VK2



Le schéma n'est valable qu'avec les références produits indiquées. Pour toute modification, veuillez prendre contact avec le service technique.

Le carter doit être relié à la terre en utilisant l'écrou de fixation prévu à cet effet.

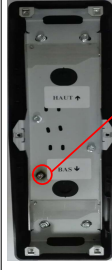

DISTANCES ET NOMBRE POSTES MAXIMUM INTERPHONIE

	Nombre max de postes	A	B	A + B	C	SOMME DE TOUS LES SEGMENTS DE A, B et C	D	E + F
Cable URMP7 REF : 1083/90	127	50m	200m	200m	200m	800m	5m	200m
SYT1 Ø 0,8mm OU 0,8mm	64	50m	150m	150m	100m	600m	5m	—
CATS UTP 100 PAIR Cat5e	64	50m	125m	125m	100m	800m	5m	—
HVV05-F 1,5mm²	127	50m	125m	125m	50m	300m	5m	—
Cable 1mm²	32	50m	75m	75m	50m	150m	5m	—

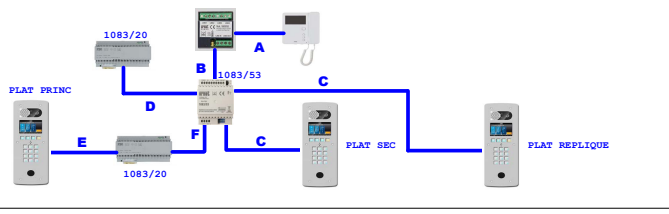

DISTANCES CONTROLE ACCES CV1083

	Alim Centrale	Alim Ventouses	Bus Plat Cent (REF 20 ou 25)	Bouton sortie (BP+ BP-)
Cable URMP7 REF : 1083/90	50m	50m	—	—
Cable 1mm²	50m	50m	—	—
HVV05-F 1,5mm²	100m	100m	—	—
SYT1 Ø 0,8mm	25m	25m	100m	100m

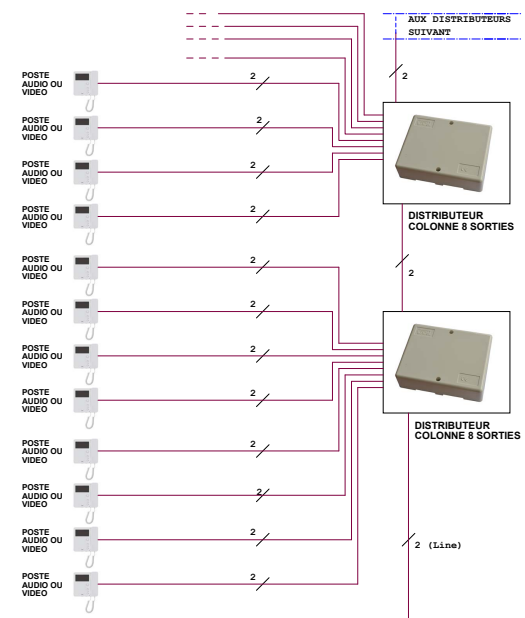

"LOCAL TECHNIQUE"

ALIMENTATION BUS 2VOICE

ALIMENTATION BUS 2VOICE

INTERFACE COLONNE

ALIMENTATION CENTRALE X3

ALIMENTATION GÂCHE/VENTOUSE X3

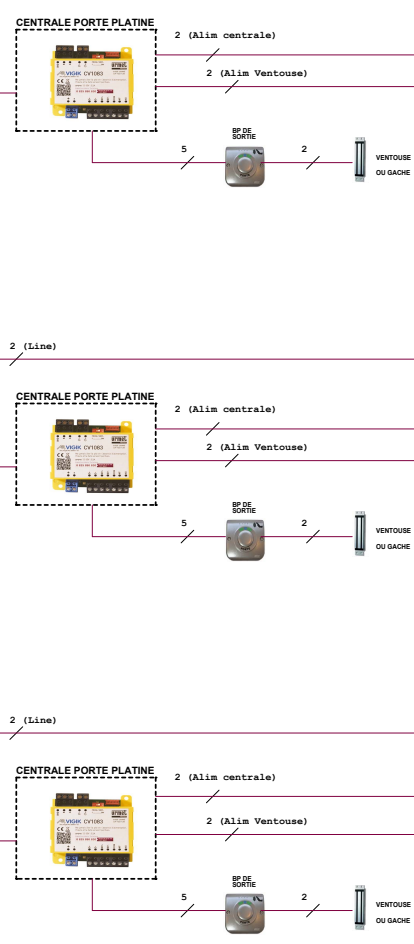

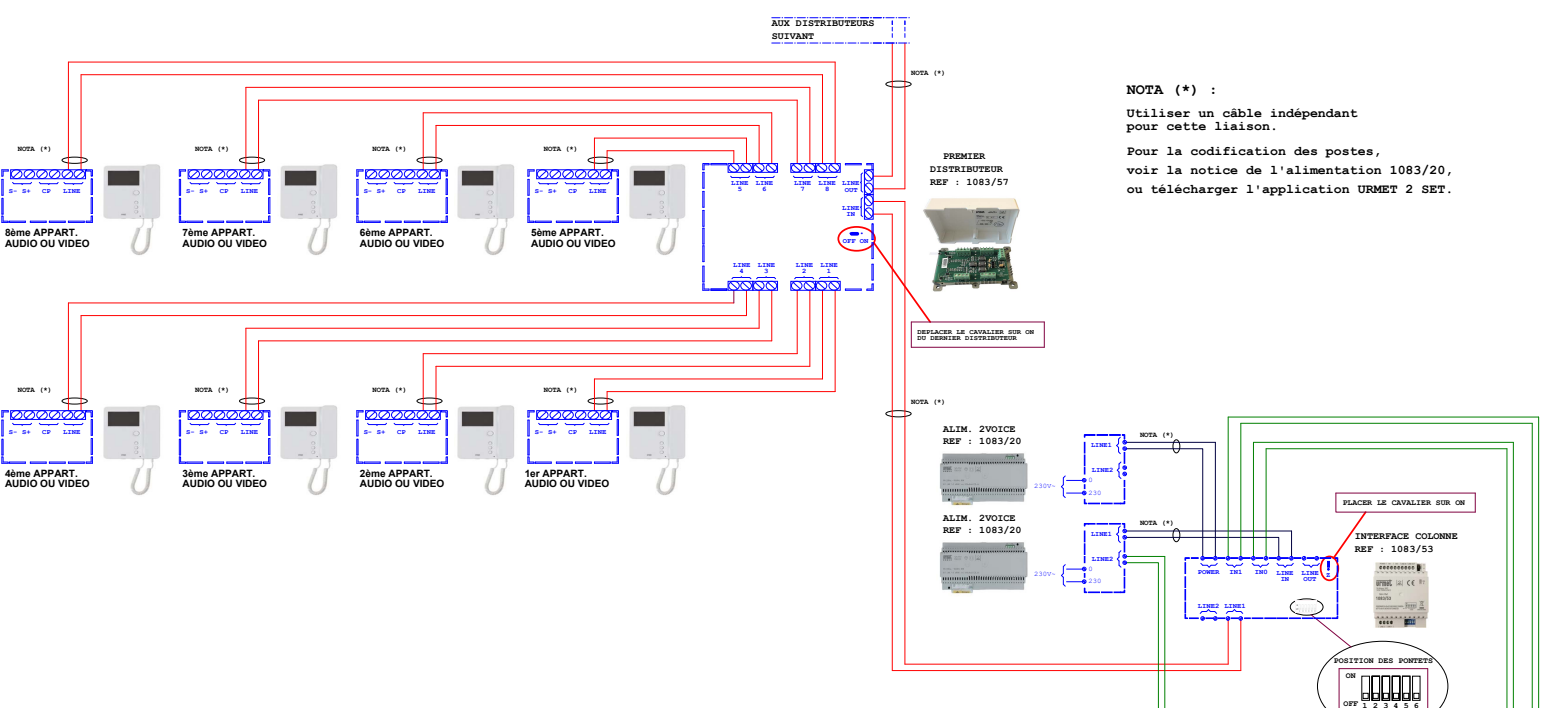

La référence 1083/53 remplace la référence 1083/50.
Si vous possédez une 1083/50, il faut reprendre les mêmes bornes que la 1083/53.

