

DISTANCES ET NOMBRE POSTES MAXIMUM INTERPHONE

	Nbre max de postes	A	B	A + B	C	CONSEIL DE TOUTES LES PRESSIONS DE A. B. & C.		
						D	E	F+G
Câble URMET REF : 1083/90	127	50m	200m	200m	200m	800m	5m	200m
SYTI 0,8mm	64	50m	150m	150m	100m	600m	5m	/
CATS UTP	64	50m	125m	125m	100m	800m	5m	/
HVV05-F 1,5mm²	127	50m	125m	125m	50m	300m	5m	/
Câble 1mm²	32	50m	75m	75m	50m	150m	5m	/

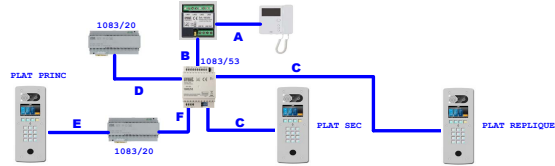

MATERIEL UTILISABLE SUR CE TYPE D'INSTALLATION :

- PLAQUE DE RUE VIDEO 2VOICE:

- REF : D83I
- OU REF : D83IG
- OU REF : D83IGLPP
- OU REF : D83IGLPPTT
- OU REF : D83IGPT
- OU REF : D83ILPP
- OU REF : D83ILPPTT
- OU REF : D83IPT
- OU REF : D83IZG
- OU REF : D83IZGLPP



- CARTE RELAIS :

REF : C83/2R



- CÂBLE BUS 2VOICE:

REF : 1083/90 (100m)
OU REF : 1083/95 (500m)



- TÊTE DE LECTURE:

REF : T2SPLUS

- CENTRALE :

REF : VIT2SPLUS



- ALIMENTATION BUS 2VOICE:

REF : 1083/20



- INTERFACE COLONNE

REF : 1083/53



- DISTRIBUTEUR COLONNE

REF : 1083/55 (4 sorties)
OU
REF : 1083/57 (8 sorties)



- POSTES

REF : 1183/4 REF : 1183/5 REF : 1183/7



- BOUTON DE SORTIE

REF : BA/OF/90LH ou BPZGML



- ALIMENTATION GÂCHE/VENTOUSE

REF : AL12/2DIN



Le schéma n'est valable qu'avec les références produits indiquées. Pour toute modification, veuillez prendre contact avec le service technique.

DISTANCES CONTROLE ACCES VIT2SPLUS

	Alim Centrale	Alim Ventouses	Box Plat. Cent. (BP+ BP-)	Bouton sortie (BP+ BP-)
Câble URMET REF : 1083/90	50m	50m	/	/
Câble 1mm²	50m	50m	/	/
HVV05-F 1,5mm²	100m	100m	/	/
SYTI 0,8mm	25m	25m	100m	100m



Le carter doit être relié à la terre en utilisant l'écrou de fixation prévu à cet effet.

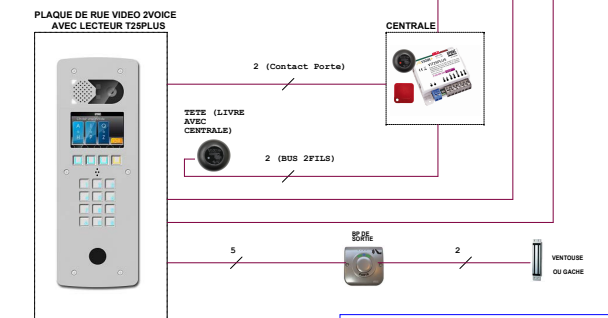
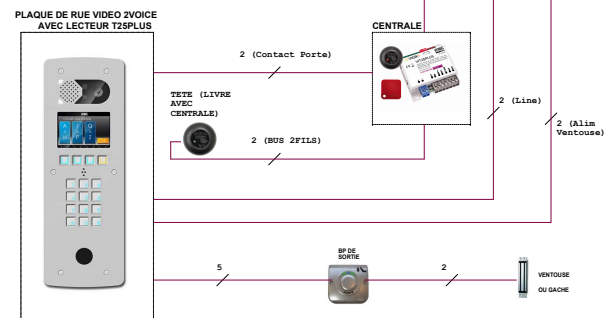
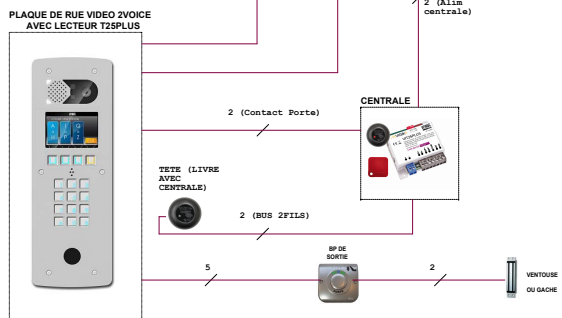
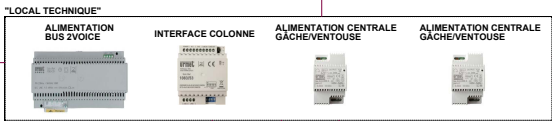
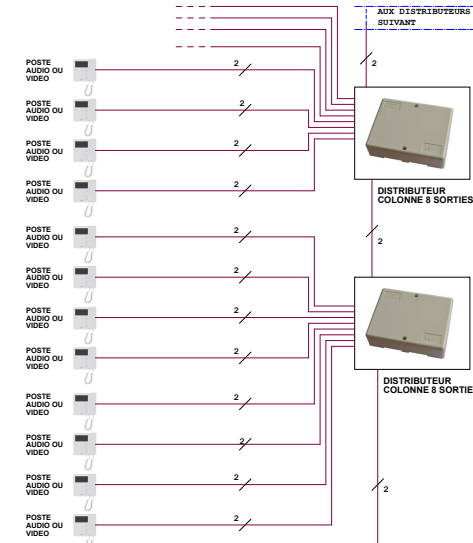

Placer le carter à la terre

Placer le carter à la terre

Placer le carter à la terre

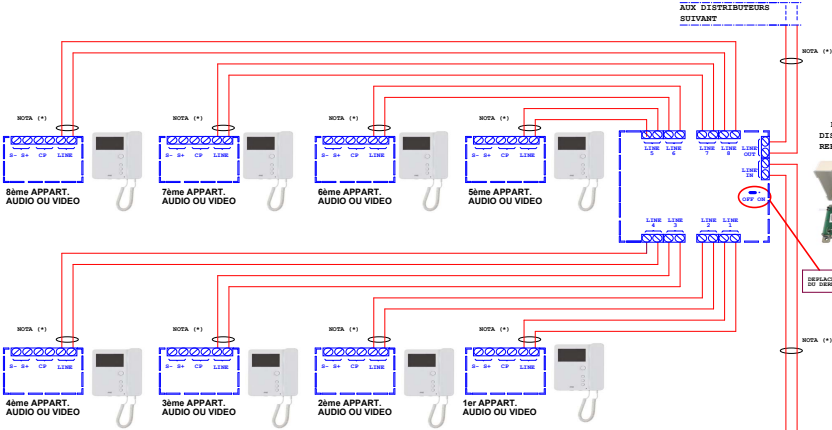

NOTA (*) :
 Utiliser un câble indépendant pour cette liaison.
 Pour la codification des postes, voir la notice de l'alimentation 1083/20, ou télécharger l'application URMET 2 SET.

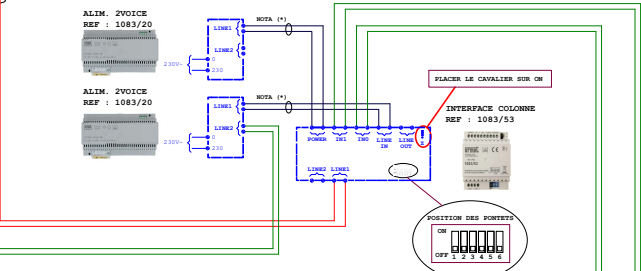
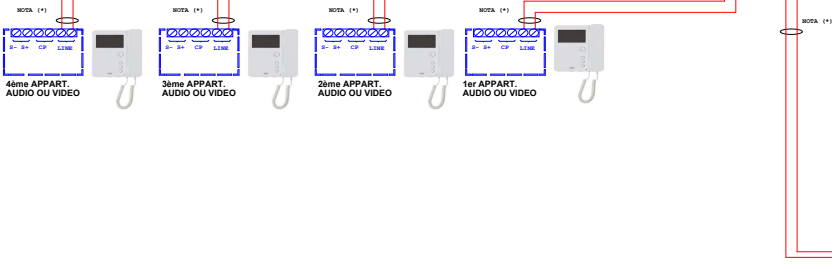

La référence 1083/53 remplace la référence 1083/50. Si vous possédez une 1083/50, il faut reprendre les mêmes bornes que la 1083/53.

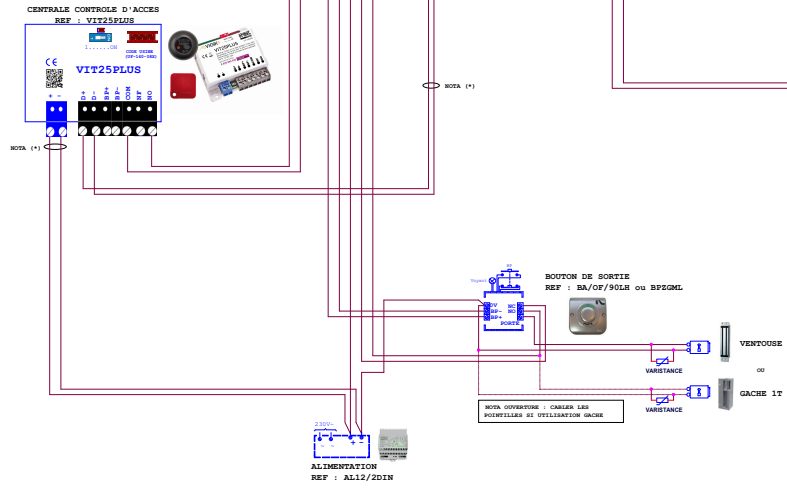
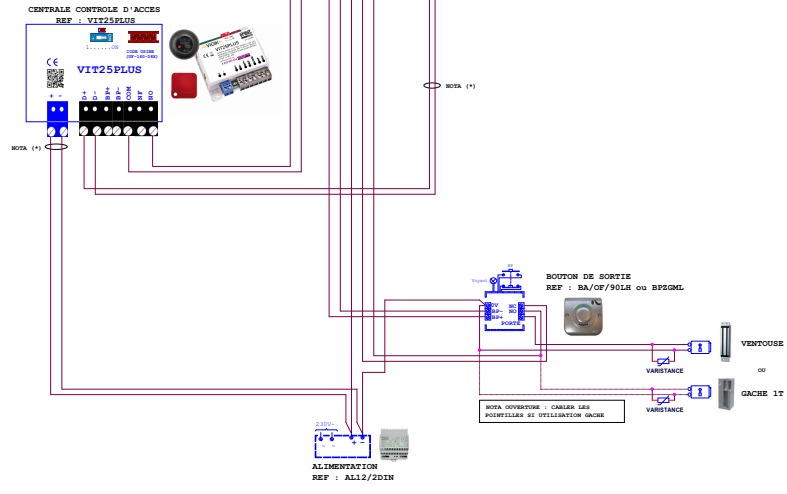
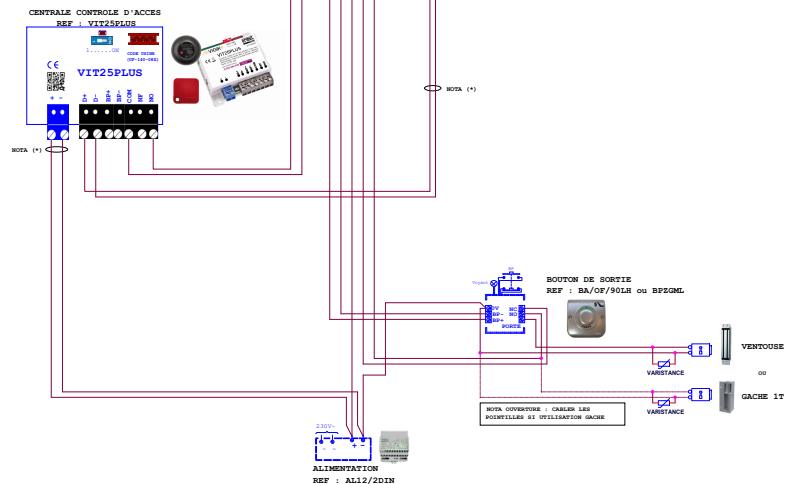
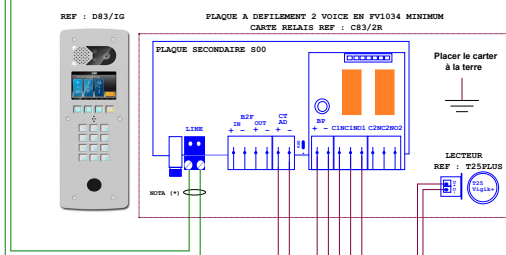
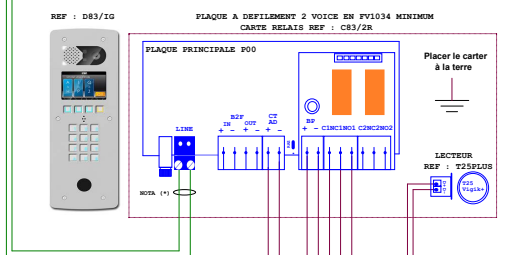
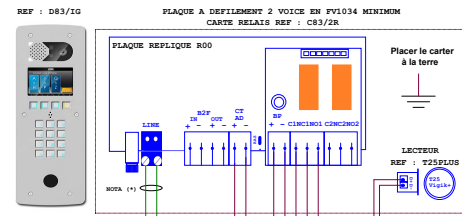

Pour faire fonctionner l'ouverture de porte avec les badges, aller sur le "Menu principale" de la plaque de rue. Puis aller dans "Paramètres" -> "Paramètres porte et relais" -> Mettre "CT(1)/AD(2)/Relai(3)" en position 3 "Rel".